

Item# 35-7009

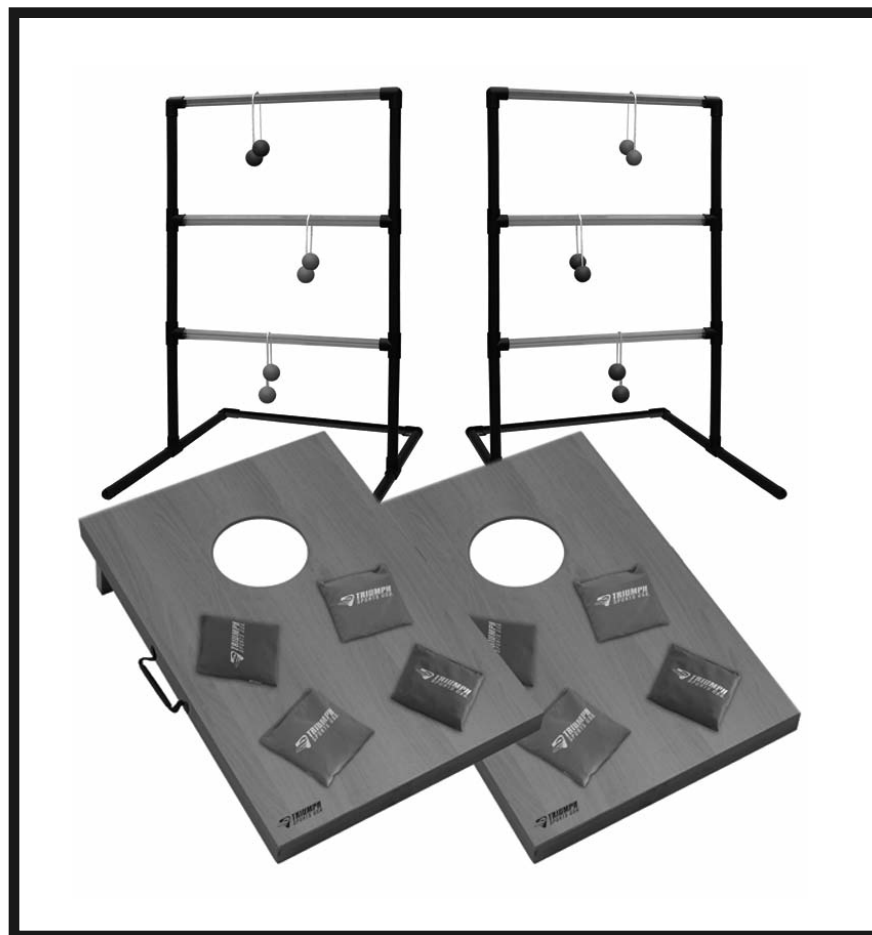









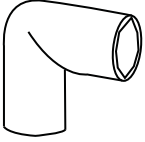
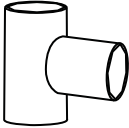

2 in 1 Tournament Toss

Ladder Toss ● Bag Toss

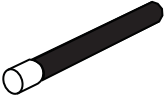

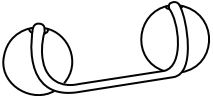
**If you have any problems with your new product,
DO NOT RETURN IT TO THE STORE!**
Please contact us at 1-866-815-4173,
or e-mail us at csr@triumphsportsusa.com

Parts List

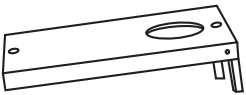
<p>#1 Corner Joint</p>  <p>4PCS</p>	<p>#2 T-Joint</p>  <p>12PCS</p>	<p>#3 Black Tube</p>  <p>12PCS</p>	<p>#4 Transparent Tube</p>  <p>6 PCS</p>
<p>#5 Base Tube With Corner Joint</p>  <p>4PCS</p>	<p>#6 Base Tube (Side)</p>  <p>4 PCS</p>	<p>#7 Base Tube (Back)</p>  <p>2PCS</p>	<p>#8 Blue Bola</p>  <p>3PCS</p>
<p>#9 Red Bola</p>  <p>3 PCS</p>	<p>#10 Blue Bag</p>  <p>4 PCS</p>	<p>#11 Red Bag</p>  <p>4 PCS</p>	<p>#12 Game Platform</p>  <p>2PCS</p>

NOTE: Unpack and remove all components from the game board. Check parts to see that all the parts are accounted for before installing the ladder.

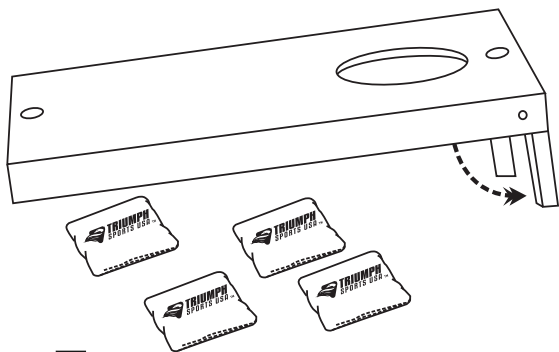

Bag Toss

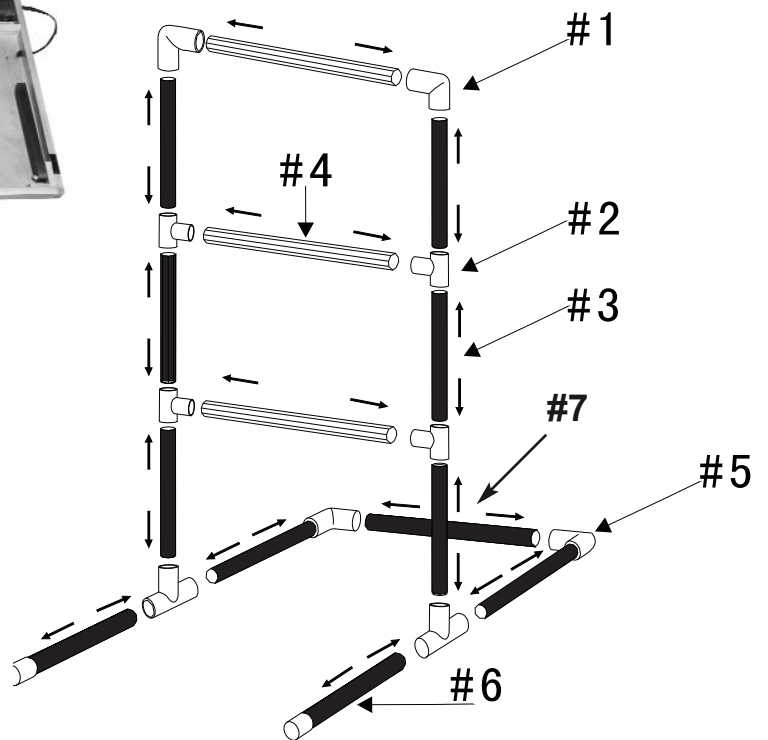

Ladder Toss



Ladder Toss

2 to 4 players, singles (2) or partners (4)

Preparation: Set ladders 15 feet apart.

Playing the Game:

The official playing distance is 15 feet between the ladders. Adjust the distance as needed for children.

Ladder toss is played by each player tossing 3 ropes to the desired ladders. The first player throws all 3 ropes at the desired ladders. When finished, the next player throws 3 ropes at the same ladders as the first player. The players' partners will then total up the scores and take turns throwing the ropes. The team with the highest score throws first.

Ropes can be thrown any way the player chooses as long as they are thrown individually. Players can bounce ropes off the ground. The game is over when a player reaches 21 points. In order to win, a player must be the only person to score exactly 21 points.

If any person scores over 21 points, his or her points for that round do not count. For example: a player with 18 points needs 3 points to get to 21 and win. If that player has 5 points hanging on the ladder after all players have thrown all ropes, the 5 points do not count and the player will enter the next round with 18 points, again needing 3 points to win.

In case of a tie, the players must play until one player scores 2 or more points more than all the other players. This 2-point rule only applies in overtime rounds. During regular play, any player can win as long as that player is the only one to score exactly 21 points, regardless of how many points the other players have.

Scoring:

Scoring is determined by the ropes that are still hanging from the steps after all teams have tossed all of their ropes. Players can knock off ropes during the course of the game, and knocking off other players' ropes is encouraged as good defensive play. Ropes that are knocked off during play should not be counted towards point totals. Only ropes that remain hanging after all ropes are tossed should be counted.

Points:

Points are determined by the steps that a player's rope wraps around. The top step is worth 2 points, the middle step is worth 2 points, and the bottom step is worth 1 point. Players can score an optional bonus point by hanging all 3 ropes from the same step or by hanging a rope on all 3 (1-2-3) steps in one round. The highest amount of points available per player per round is 10. This is accomplished by hanging all 3 ropes on the top (3 point) step.

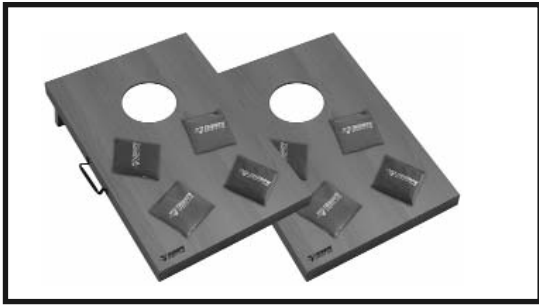

BAG TOSS

2 to 8 players

Preparation: Set boxes 15 feet apart.

Game Rules:

Each team has 4 Bean Bags. Players should alternate throws during their team's turn.

Hint: You can knock your opponent's Bean Bags off the board.

A bag thrown through the hole earns 3 points. A bag that lands on the board earns 1 point. Subtract the low score from the high score for each round of play. For example: Team A has 1 bag in the hole and 2 bags on the board, for a score of 5 points. Team B has two bags on the board, for a score of 2 points. Team A (5 points) - Team B (2 points) = Team A (3 points). Team A receives 3 points for that round of play.

Be sure to check out all the exciting outdoor games  has to offer.

Visit our web site at:

www.triumphsportsusa.com



Bag Toss Tournament
Item# 35-7011



Washer Toss Tournament
Item# 35-7012



Ladder Toss With
Glow Game Pack
Item# 35-7017



Bag Toss With
Glow Game Pack
Item# 35-7026

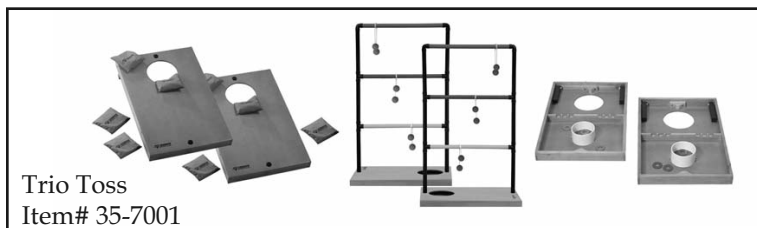

Trio Toss
Item# 35-7001

CAUTION: Contains small parts. Not intended for children under 3 years.

90-Day TSU Game Warranty

All TSU games have a 90-days from date of purchase warranty. This warrants the retail purchaser for any TSU games purchased to be free from any defects in materials and construction for 90 days from the date of purchase. Normal play wear and usage is not covered under the warranty, nor is wear or damage due to improper use of the TSU game. This will void any and all TSU warranty.

If you have any problems with your new product DO NOT RETURN IT TO THE STORE.
Please contact us at 1-866-815-4173 or email us at csr@triumphsportsusa.com.

Triumph Sports USA

Aurora, IL 60504

www.triumphsportsusa.com

©2008 Triumph Sports USA. All Rights Reserved.

2 IN 1 TOURNAMENT TOSS REPLACEMENT PARTS ORDER FORM

Quantity Ordered	Part Number	Item Description	Price	Sub-Total
	35-7009-1	Corner Joint	\$0.50 ea	
	35-7009-2	T-Joint	\$0.50 ea	
	35-7009-3	Black Tube	\$1.99 ea	
	35-7009-4blue	Transparent Tube (Blue)	\$2.50 ea	
	35-7009-4green	Transparent Tube (Green)	\$2.50 ea	
	35-7009-4yellow	Transparent Tube (Yellow)	\$2.50 ea	
	35-7009-5	Base Tube With Corner Joint	\$2.50 ea	
	35-7009-6	Base Tube (Side)	\$1.99 ea	
	35-7009-7	Base Tube (Back)	\$1.99 ea	
	35-7009-8	Blue Bola	\$7.00 (set of 3)	
	35-7009-9	Red Bola	\$7.00 (set of 3)	
	35-7009-10	Blue Bag	\$9.99 (set of 4)	
	35-7009-11	Red Bag	\$9.99 (set of 4)	
	35-7009-12	Game Platform	\$19.99 (1pc)	

Sub-Total	
Shipping & Handling	\$5.95
Total Cost	

Name _____

Address _____

City _____ State _____ Zip Code _____

Daytime Phone No. _____ Email address _____

UPC Number _____

Method Of Payment:

CHECK MONEY ORDER VISA MASTERCARD

AMERICAN EXPRESS DISCOVER

Card No.

--	--	--	--	--	--	--	--	--	--	--	--	--	--	--	--	--	--	--	--

Name On Card: _____ Expiration Date: _____

Signature: _____

Please make all checks or money orders payable to: Triumph Sports USA

Mail this order form to:

Triumph Sports USA

1005 N. Commons Drive

Aurora, IL 60504

Or fax the form to 262-364-2254