

Be sure to check out all the exciting products
Rush Creek has to offer. Visit our web site at:

www.triumphsportsusa.com



Warranty:

All of our products come with a one year warranty on all parts.

Manufacturer Defects:

Defective parts will be replaced at no cost to you. Please send an e-mail to Customerservice@triumphsportsusa.com including photos of the defective part(s) and we will send replacements. PLEASE NOTE: Cracks in logs are not defects. They may develop during the log drying process and do not affect the stability of the piece in any way, and add to the rustic appeal of your log furniture.

If your product needs service, please be advised that Triumph Sports USA reserves the right to decline service when the product is found to be excessively worn, altered in any way, or when damage is caused by acts other than defective workmanship or materials. This warranty is void if the product has been subject to abuse. For service under this warranty, please contact Triumph Sports USA. Please provide your receipt as proof of purchase.



Triumph Sports USA
Aurora, IL 60504
www.triumphsportsusa.com
Rush Creek is a trademark owned by Triumph Sports USA
©2008 Triumph Sports USA. All Rights Reserved.

Item # 37-0035



Rush Creek™

DINING SET



Tools Needed For Assembly:

Screwdriver

Assembly Tips:

Use wood glue (included) to glue the joints. This will provide a stronger bond for your table joints.

If you are using an electric screw driver for assembly, set it at low torque and do not over-tighten the hardware.







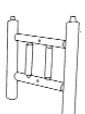
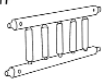

Care:

Apply lemon oil with a soft cotton cloth. Do not use products with silicone; these may cause damage to the finish. Do not allow the wood to come in contact with any type of paint remover.

CONNECTIONS:

Changes in temperature and humidity may cause the wood to dry out, which can cause the bolts to loosen. Check the bolts periodically to make sure they are still tight. DO NOT put your wood furniture directly against hot radiators or other sources of heat. This may cause the wood to dry and crack.

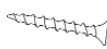
Parts List

<p>1#</p>  <p>2PCS</p>	<p>2#</p>  <p>1PC</p>	<p>3#</p>  <p>1PC</p>	<p>4#</p>  <p>4PCS</p>
<p>5#</p>  <p>4PCS</p>	<p>6#</p>  <p>4PCS</p>	<p>7#</p>  <p>4PCS</p>	<p>8#</p>  <p>4PCS</p>
<p>9#</p>  <p>1PC</p>	<p>10#</p>  <p>4PCS</p>		

Step 1

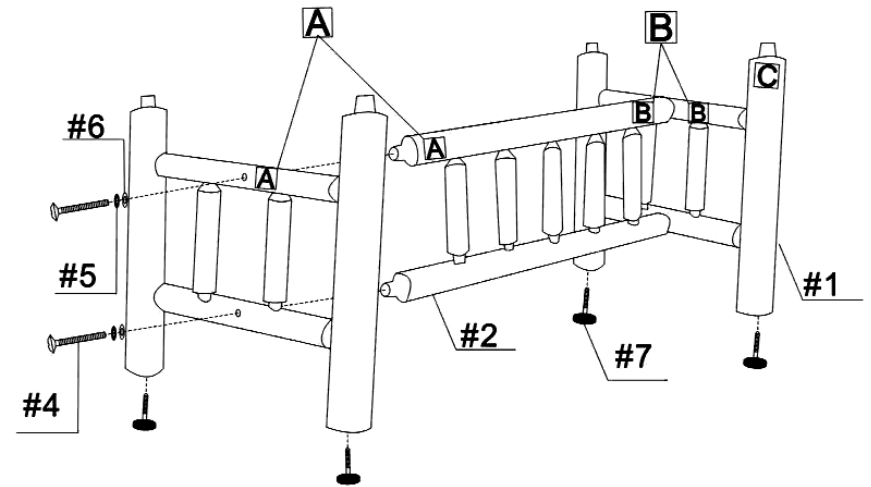

Step 2

