



Item # 45-6043

Center Line

Air Powered **HOCKEY TABLE**





WARNING:

At least two adults are needed to put this game table together.

Tools Needed For Assembly:

Screwdriver

Allen wrench (included)

Level

Assembly Tips:











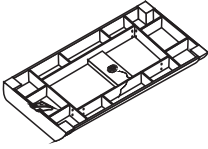

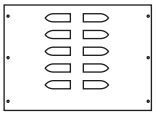
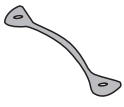

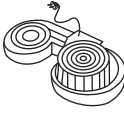

Some drawings or images in this manual may not look exactly like your product. Please read and understand the text before starting each assembly step.

If you are using an electric screw driver in assembly, please set at low torque and do not overtighten the hardware.

HOCKEY:

- 1) This game is designed to be played with two (2) players, one at each end, or with four (4) players, two at each end of the game table.
- 2) Play begins when the puck is placed on the playing surface. Players must hit the puck with the hand-held pushers and attempt to shoot into the opponent's goal.
- 3) One point is given when a puck is shot into the opponent's goal.
- 4) Winning: the winning goal is accomplished by being the first player to reach a predetermined score or by being the player to score the most points within a given period.

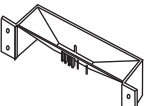
Parts List

<p>①</p>  <p>CABINET ASSEMBLY 1EA</p>	<p>②</p>  <p>LEG 4EA</p>	<p>③</p>  <p>LEG END PANEL 2EA</p>	<p>④</p>  <p>LEG PANEL SUPPORT 2EA</p>	<p>⑤</p>  <p>8X40MM LEG BOLT 16EA</p>	<p>⑥</p>  <p>22MM FLAT WASHER 16EA</p>
<p>⑦</p>  <p>3.5X28MM WASHER HEAD SCREW12EA</p>	<p>⑧</p>  <p>3.5X25MM FLAT HEAD 4EA</p>	<p>⑨</p>  <p>3.5X12MM WASHER HEAD SCREW4EA</p>	<p>⑩</p>  <p>PRE-INSTALLED MOTOR 1EA</p>	<p>⑪</p>  <p>PUCK RETURN UNIT 2EA</p>	<p>⑫</p>  <p>PUSHER RED</p>
<p>⑬</p>  <p>PUCK 4EA</p>	<p>⑭</p>  <p>SCORER 2EA</p>	<p>⑮</p>  <p>LEG LEVELER 4 EA</p>	<p>⑯</p>  <p>PRE-INSTALLED INDUCTANCE BOX 2EA</p>	<p>⑰</p>  <p>ALLEN KEY 1EA</p>	<p>⑱</p>  <p>PUSHER BLUE</p>

Step 1

Attach legs (#2) to the base frame using leg bolts (#5) and washers (#6).

IMPORTANT: Do not completely tighten leg bolts until step 3 and 4 are completed.

Step 2

Attach Puck return unit (#11) to each end of the base frame using washer head screws (#9).

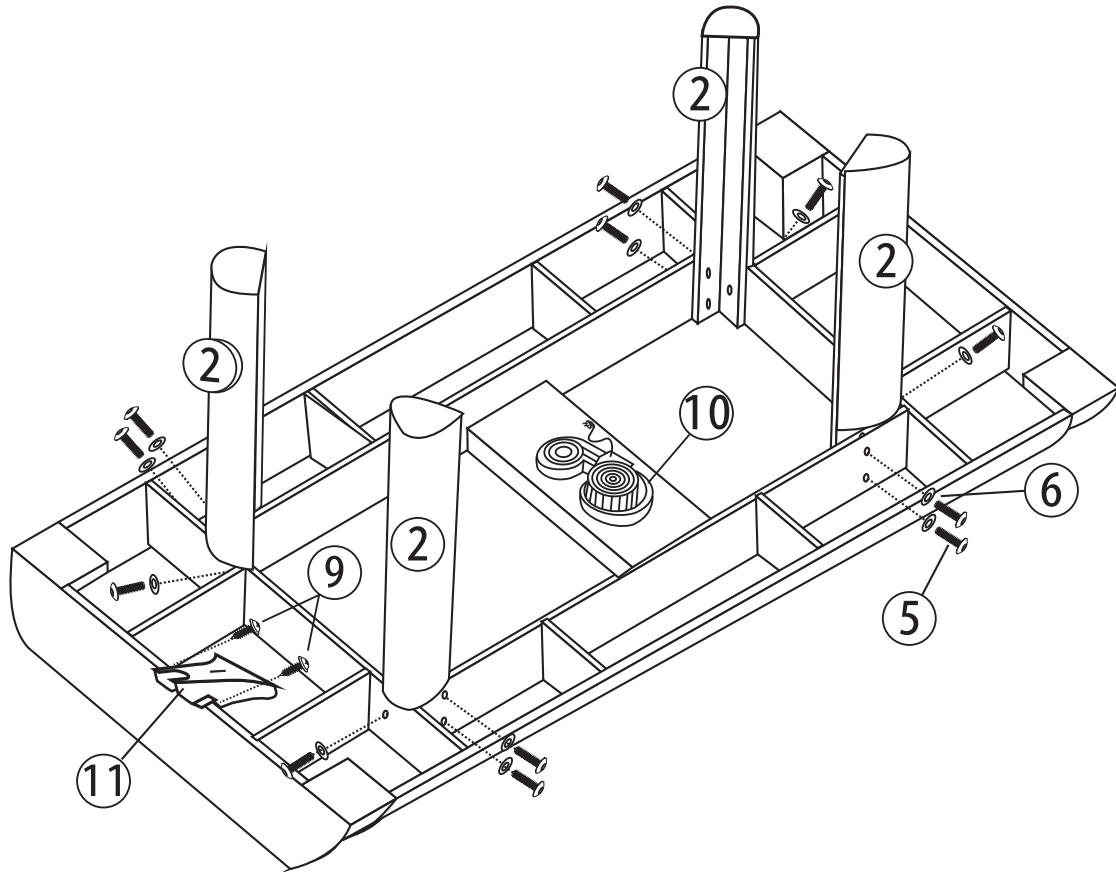

Step 3

Slide end panel (#3) into the tracks on the inside of the legs.

Step 4

Attach leg panel support (#4) to the top of the legs using washer head screws (#7).

Step 5

Screw in leg levelers (#15) into each leg and turn table over.

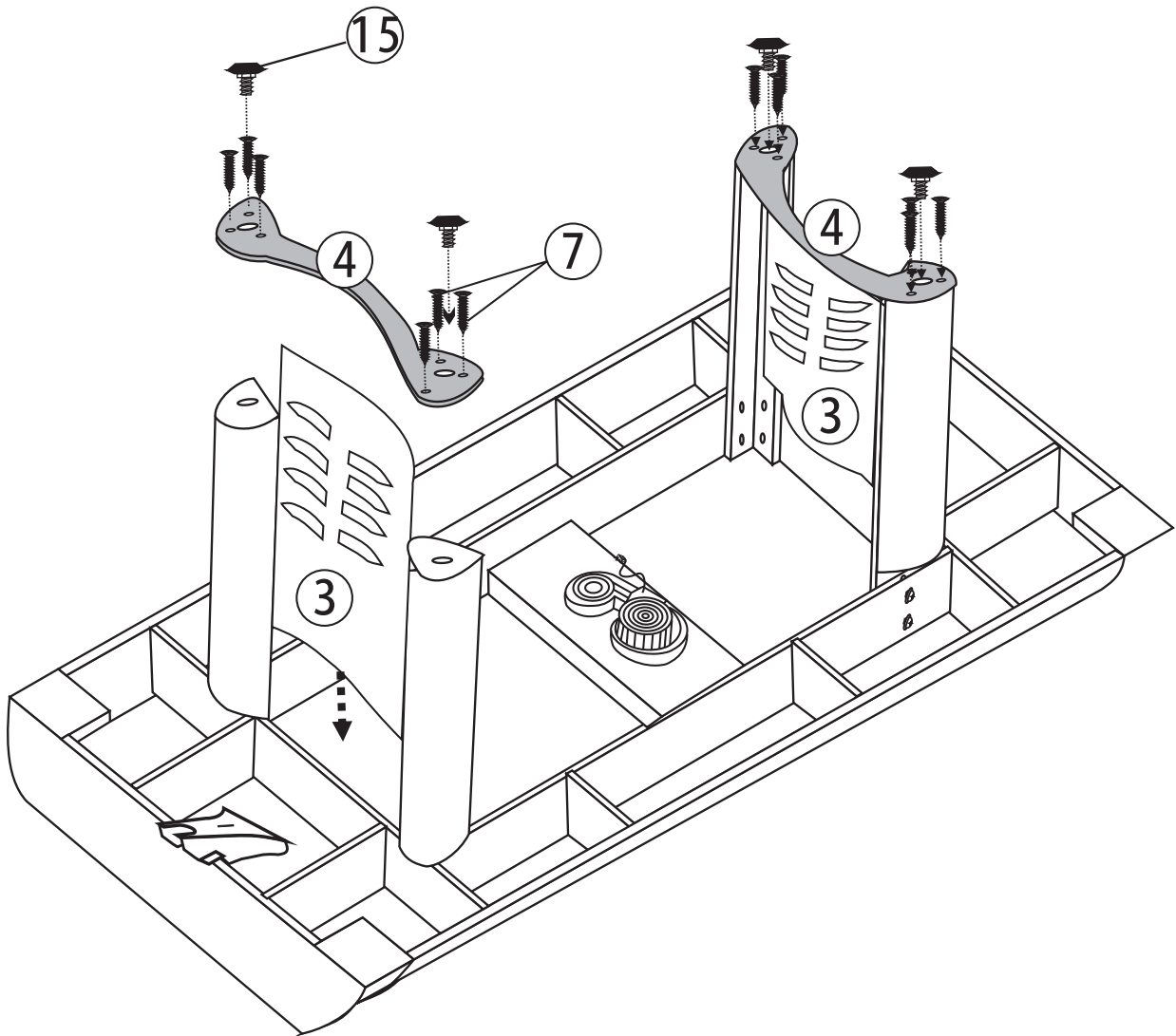

Step 6

Using flat head screws (#8) attach score units (#14) to each end of the rail.

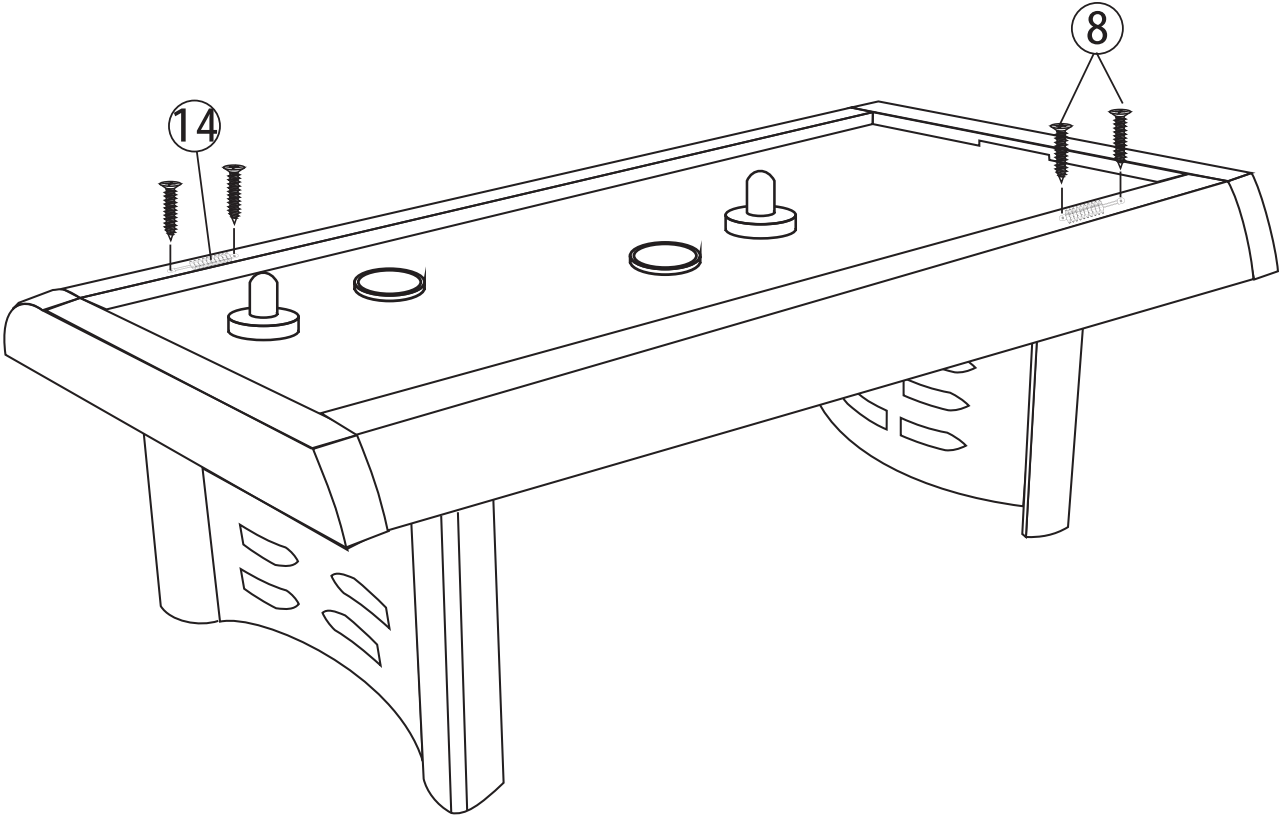

Be sure to check out all the exciting games  has to offer.

Visit our web site at:

www.triumphsportsusa.com



90 day TSU Game Warranty

All TSU games have a 90 day from date of purchase warranty. This warrants the retail purchaser for any of the TSU games purchased to be free from any defects in materials and construction for 90 days from date of purchase. Normal play wear and usage is not covered under the warranty or improper use of any TSU game. This will void any and all TSU warranty.

If you have any problems with your new product, DO NOT RETURN IT TO THE STORE, please contact us at 1-866-815-4173, or email to Customerservice@Triumphsportsusa.com

Triumph Sports USA

Aurora, IL 60504

www.triumphsportsusa.com

©2008 Triumph Sports USA. All Rights Reserved.